

Rotary Switch 8-position Low-profile Vertical Type

SRBV Series

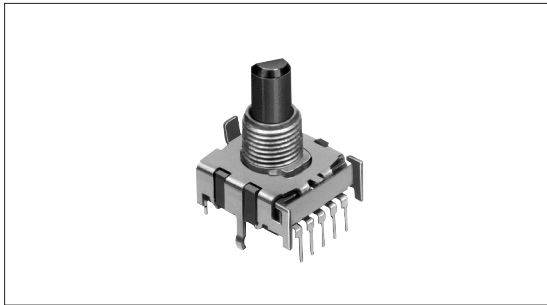

Low-profile 7.5mm height contributes to flexibility in set design.



Typical Specifications

Items		Specifications
Rating (max.) / (min.) (Resistive load)		0.3A 16V DC/50μA 3V DC
Contact resistance (Initial/After operating life)		50mΩ max./150mΩ max.
Rotational torque		30 ± 15 mN·m
Operating life	Without load	10,000cycles
	With load	10,000cycles (0.3A 16V DC)

Detector

Push

Slide

Rotary

Encoders

Power

Dual-in-line
Package Type

TACT Switch™

Custom-
Products

Product Line

Poles	Positions	Changeover angle	Changeover timing	Actuator configuration	Actuator length (mm)	Minimum order unit (pcs.)	Product No.
1	3	30 ± 3°	Non shorting	Flat	L=15	330	SRBV131803
					L=20		SRBV131502
	4				L=15		SRBV141404
					L=20		SRBV141201
	5				L=15		SRBV151102
					L=20		SRBV150901
	6				L=15		SRBV160803
					L=20		SRBV170701
	7				L=15		SRBV170501
					L=20		SRBV181004
	8				L=15		
					L=20		

Packing Specifications

Bulk

Number of packages (pcs.)		Export package measurements (mm)
1 case /Japan	1 case /export packing	
165	330	400 × 270 × 185

Notes

1. Products other than those listed in the above chart are also available. Please contact us for details.
2. Please place purchase orders per minimum order unit N (integer).



Automotive
Use

Refer to P.192 for shaft configurations.
Refer to P.194 for attached parts.

Rotary Switch 8-position Low-profile Vertical Type | SRBV Series

Dimensions

Unit:mm

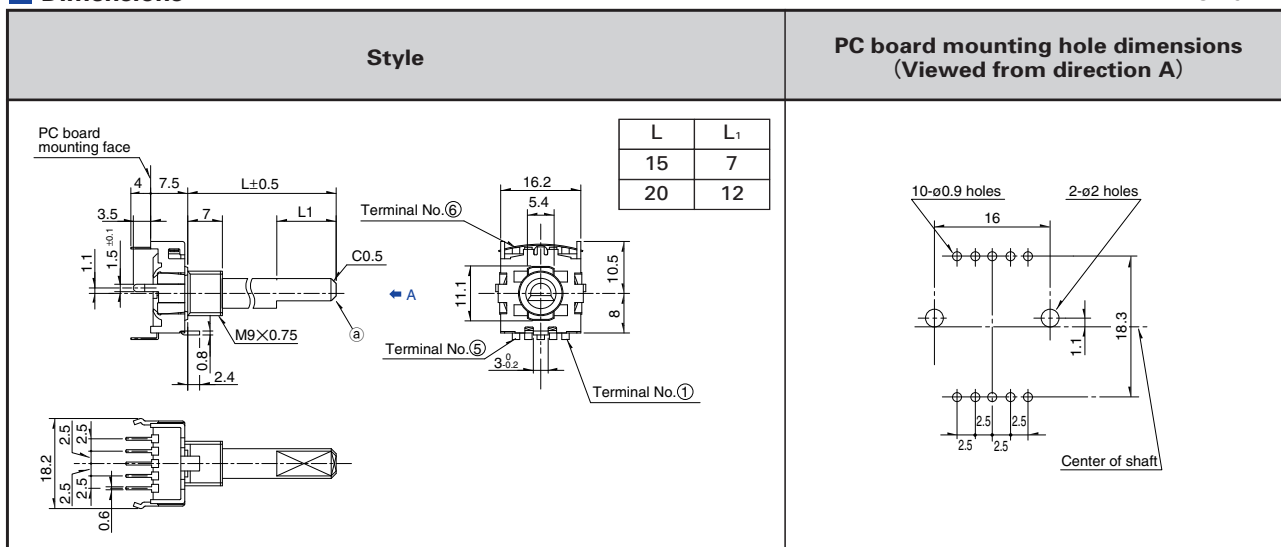

Operation Part Details ① Unit:mm

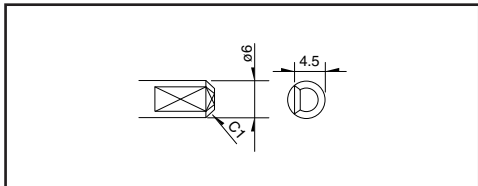

Standard Circuit Diagram (Viewed from Direction A)

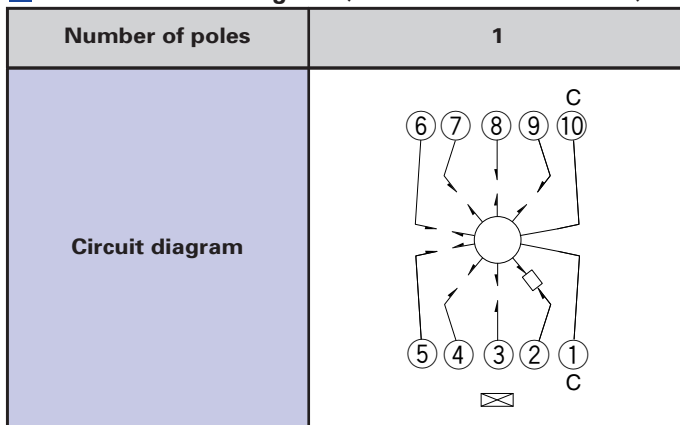





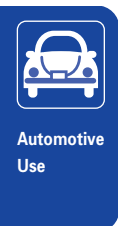



Dummy Terminals

3-positions	⑤ ⑥ ⑦ ⑧ ⑨
4-positions	⑥ ⑦ ⑧ ⑨
5-positions	⑦ ⑧ ⑨
6-positions	⑧ ⑨
7-positions	⑨
8-positions	—

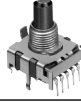

List of Varieties

Series		SRBD	SRBQ		SRRM	SRBV	SRBM		SRRN						
			Insertion	Reflow type			Rotary	Pulse							
Photo															
Outline specifications	Step angle	36°	40±3°		30±3°			18±3°	30±3°						
	Number of poles	1		1 2 3 4	1	1 2	2 3 4								
Dimensions (mm)		W	11.4		—	16.2	12.5		—						
		D	12.4			18.5	10								
		H	3.5			7.5	11.5								
Operating temperature range		-25°C to +85°C		-10°C to +60°C		-40°C to +85°C		-10°C to +60°C							
Automotive use		—		—		●	●		—						
Rating(max.)/(min.) (Resistive load)		1mA 5V DC 50μA 3V DC		0.1A 16V DC 50μA 3V DC		0.25A 30V DC 50μA 3V DC		0.3A 16V DC 50μA 3V DC		0.1A 16V DC 50μA 3V DC					
Electrical performance	Insulation resistance		100MΩ min. 100V DC			100MΩ min. 500V DC		100MΩ min. 100V DC		100MΩ min. 500V DC					
	Voltage proof		100V AC for 1minute			500V AC for 1minute		100V AC for 1minute		500V AC for 1minute					
	Terminal strength		3N for 1minute		5N for 1minute		10N for 1minute		5N for 1minute						
Mechanical performance	Actuator strength	Rotational direction	—		1N·m		0.6N·m		0.5N·m		—		1N·m		
		Push direction	50N		20N		100N								
	Wobble of actuator		Load at the tip of shaft SRRM : 5N SRBV, SRBQ : 1N (Unit : mm)			The below table shows for SRBQ (Unit : mm)			The below table shows for SRBV (Unit : mm)			Measuring position from mounting surface	Shaft wobble (max.value)	Applicable mounting dimension	
			Measuring position from mounting surface	Shaft wobble (max.value)	Applicable mounting dimension	Distance from mounting surface to the tip of shaft	Shaft wobble (max.value)	Measuring position from mounting surface	Shaft wobble (max.value)	Applicable mounting dimension	10mm	0.17 mm	15 mm		
10			0.17	15	below 5	0.5 max.	10	0.2	15	15mm	0.25 mm	20 mm			
Durability		Operating life without load		10,000cycles 250mΩ max.		10,000cycles 100mΩ max.		10,000cycles 40mΩ max.		10,000cycles 100mΩ max.		30,000 cycles 100mΩ max.		10,000cycles 70mΩ max.	
		Operating life with load Load : (at rated load)		10,000cycles 250mΩ max.		10,000cycles 100mΩ max.		10,000cycles 60mΩ max.		10,000cycles 150mΩ max.		10,000cycles 100mΩ max.			
Environmental performance	Cold		-40±2°C for 500h		-20±2°C for 96h										
	Dry heat		85±2°C for 500h		85±2°C for 96h										
	Damp heat		60±2°C, 90 to 95%RH for 500h		40±2°C, 90 to 95%RH for 96h										
Soldering	Manual soldering		—		350±10°C 3 ⁺ 1s		350±5°C 3s max.		350±10°C, 3 ⁺ 1s						
	Dip soldering		—		260±5°C 5±1s		—		260±5°C 10±1s		260±3°C 5s max.		260±5°C 10±1s		
	Reflow soldering		Please see P.193		—										
Page		179		181		188		186		183		190			

- Rotary Switches Shaft Style192
- Rotary Switches Soldering Conditions193
- Rotary Switches Attached Parts194
- Rotary Switches Cautions195

Notes

●marks in "Available for automotive use" indicate that all of the series products can work at the operating temperature range from -40°C to +85°C.

Detector
Push
Slide
Rotary
Encoders
Power
Dual-in-line
Package Type
TACT Switch™
Custom-
Products

Shaft Configurations

18-tooth Serration Shaft

The shaft shows the position in which it is turned fully counterclockwise.

① Cutting Shaft

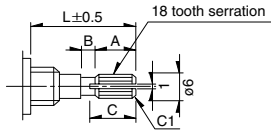

② Die Casting Shaft

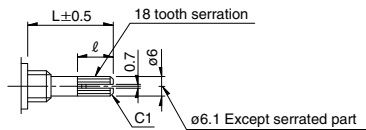

Unit:mm

Shaft length L	A	B	C
15	6	1	7
20	10	2	11

Unit:mm

Shaft length L	l
15	8
20	12

Details About Serration

- (1) The mold dimensions of standard serration and the dimensions of test jigs are as shown in the figure at left.
- (2) Position of the serration bottom
When the shaft is turned fully counterclockwise, the position of the serration bottom is on the AA line.
- (3) Slitting angle
The slitting angle (position) is not specified.

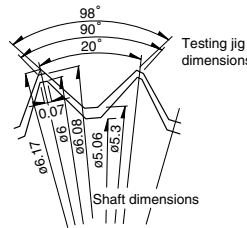

Round Shaft

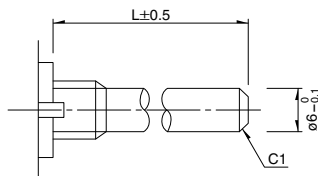

Round Shaft with Groove

The shaft shows the position in which it is turned fully counterclockwise.

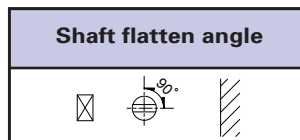
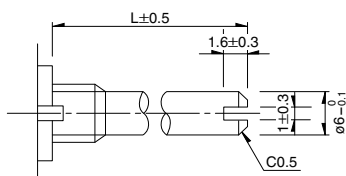

Flat Shaft

The shaft shows the position in which it is turned fully counterclockwise.

Cutting Shaft

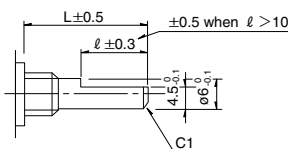

Die Casting Shaft

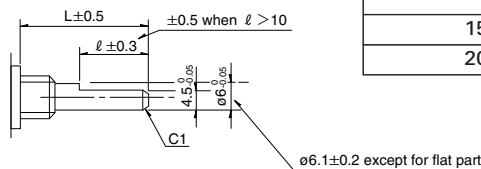

Unit:mm

Shaft length L	l
15	7
20	12

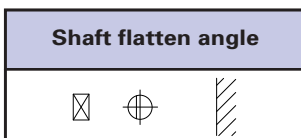

Note

SRBM Series are based on (printed terminal direction). SRRM, SRRN, SRBV Series are based on (panel lug).

Detector

Push

Slide

Rotary

Encoders

Power

Dual-in-line
Package Type

TACT Switch™

Custom-
Products

Attached Parts

The following parts are included with the product.

■ SRRM, SRBV

Unit:mm

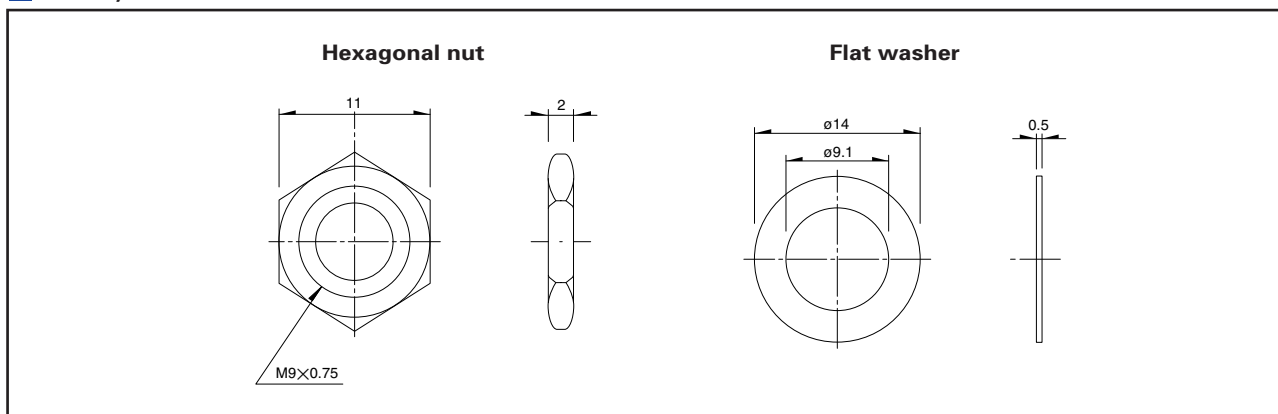

■ SRBM, SRRN

Unit:mm

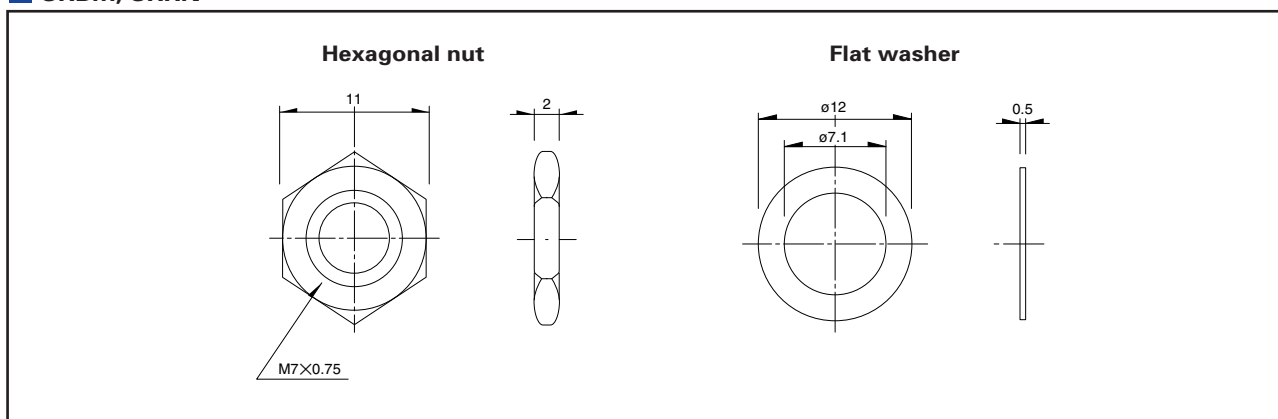

Detector

Push

Slide

Rotary

Encoders

Power

Dual-in-line
Package Type

TACT Switch™

Custom-
Products